

NuStep[®] RB8

Recumbent Bike

USER MANUAL



Contents

Introduction.....	4
Safety Instructions.....	5-6
Installation and Placement.....	7
AC Adapter Use.....	8
RB8 Feature Overview.....	9
Making Adjustments.....	10-11
Correct Riding Position	11
Display Screens.....	12-17
Pause Function	18
System Settings.....	19-21
User Settings.....	21
Exporting User Profile Data	22
Exporting Workout Summary	23
Preventive Maintenance.....	24
Warranty and Serial Number Information	25
Obtaining Customer Service and Parts	26
Technical Data.....	27
US FCC Compliance.....	28



Introduction

Thank you for purchasing the NuStep RB8 Recumbent Bike. We appreciate your business and your confidence in our products.

The recumbent bike line, which includes the RB8_{PRO} and the RB8_{MAX}, continues NuStep's tradition of innovation and its mission to develop inclusive exercise equipment that can benefit users of virtually all fitness levels and functional abilities.

Please review this manual — including all safety information — before using the RB8 Recumbent Bike.

Safety Instructions

	 CAUTION	 WARNING
<p>This is the safety alert symbol. It is used to call attention to instructions concerning personal safety. Read and obey all safety messages that follow this symbol to avoid possible injury or death resulting from misuse.</p>	<p>CAUTION indicates a potentially hazardous situation, which if not avoided, may result in minor or moderate injury. It may also be used to alert against unsafe practices.</p>	<p>WARNING indicates a potentially hazardous situation, which, if not avoided, could result in death or serious injury.</p>

 WARNING
<p>Do not modify this equipment without authorization of the manufacturer.</p> <p>Use this equipment only for its intended use as described in this manual.</p> <p>Do not use attachments not recommended by the manufacturer.</p> <p>Never operate this equipment if it has a damaged cord or plug.</p> <p>Keep cord away from heated surfaces.</p> <p>Keep product away from heat, sparks, open flames, and hot surfaces.</p> <p>Never drop or insert any object into any opening.</p> <p>Do not use outdoors.</p> <p>Injuries to health may result from incorrect or excessive training.</p> <p>Heart rate monitoring systems may be inaccurate.</p> <p>Over exercising may result in serious injury or death. If you feel faint, stop exercising immediately.</p> <p>Use of this equipment adjacent to or stacked with other equipment should be avoided because it could result in improper operation.</p> <p>Portable RF communications equipment (including peripherals such as antenna cables and external antennas) should be used no closer than 30 cm (12 inches) to any part of this product, including cables. Otherwise, degradation of the performance of this equipment could result.</p>

Safety Instructions



CAUTION

See your physician before beginning any exercise program.

Supervision is required if you have a disability or medical condition.

Stop exercising if you feel faint or dizzy while using this product, and seek medical help or advice.

Use this product only as directed by your physician if you have heart disease, hypertension, diabetes, respiratory disease, any other medical problem, or if you are pregnant.

People with reduced physical, sensory or cognitive capabilities—or lack of experience and knowledge of this product—may use this product, provided they are supervised by a person responsible for their safety.

Read this manual before using this product and save it for future reference.

Always wear shoes and proper clothing when exercising.

Do not touch or hold product with non-intact skin.

Do not operate this product if it appears damaged or inoperable. Examine product regularly for damage and wear. Ensure defective components are replaced by qualified service technicians immediately.

Do not perform maintenance or repairs on this product while it is in use. Maintenance activities shall be performed by qualified service personnel.



CAUTION

Make sure the seat position and upper arm position are correctly set up for you.

Do not over-extend your arm reach while using this product.

Do not let children use this product.

Do not use this product in the presence of children and/or pets.

Keep children under the age of 13 away from this machine.

The heart rate, watts, METs and calories displays are not suitable for use in applications where the health and safety of the patient is dependent on the accuracy of those parameters.

The maximum user weight capacity:
RB8_{PRO} model = 500 lbs (227 kg)
RB8_{MAX} model = 600 lbs (272 kg)

Do not lift this product by yourself. The RB8 is very heavy; it weighs 240 lbs. (109 kg).

To avoid injury, or damage to the product, always get assistance to move this product. Use proper lifting techniques.

To avoid injury, do not insert hands in any cover openings.

For safe operation of this product, place on a flat, stable surface. Adjust leveler feet as required.

This product is intended to be connected to AC mains power through the furnished AC adapter only.

SAVE THESE INSTRUCTIONS.

Installation and Placement

Unpacking and Installation

Carefully unpack the RB8 from the shipping container and transport the product to the installation location. The RB8 is designed for indoor use only.

For added stability and floor protection, place the RB8 on an exercise equipment floor mat such as the floor mat sold by NuStep, LLC.

To ensure the safe and effective operation of your RB8, place on a flat, stable surface. Adjust leveler feet as required.

The minimum amount of required free space around the RB8 unit is 24 inches (61 cm). Additional free space is necessary to accommodate wheelchair access.

CAUTION

The RB8 is very heavy. It weighs 240 lbs. (109 kg).

To avoid injury, or damage to the product, always obtain assistance to move this product.

Use proper lifting technique.

If there is a clicking sound coming from the lower rear of the machine (while in use), check the leveler feet to make sure they are evenly adjusted.

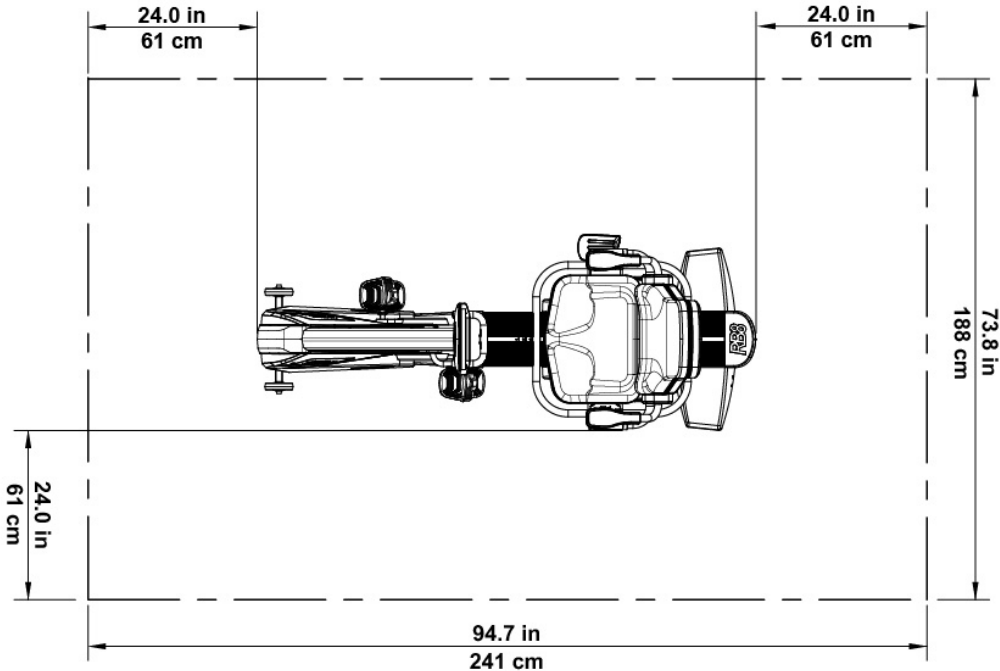

AC Adapter Use

The RB8 is powered by an AC adapter that is included with the unit. The AC adapter may be plugged into either the front or the rear jack.* Plug the adapter into an appropriate power outlet.

Route the AC adapter power cable in a way that prevents tripping hazards or damage to the adapter. Avoid placing any pressure or strain on adapter cables, jacks or plugs.

For adapter specifications, please refer to the *Technical Data* section of this manual.

**Do not connect the RB8 to two AC adapters simultaneously.*

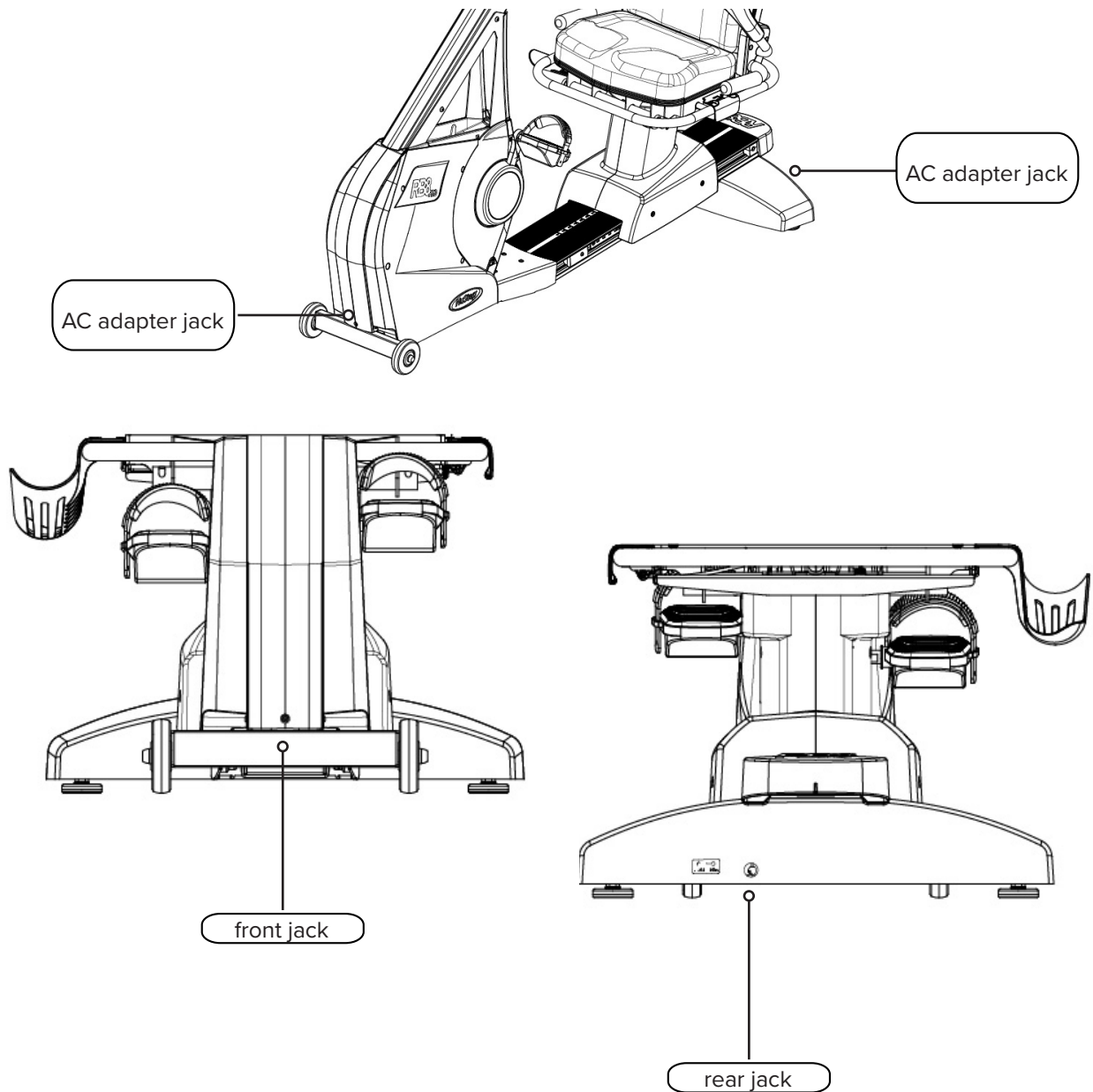

RB8 Feature Overview

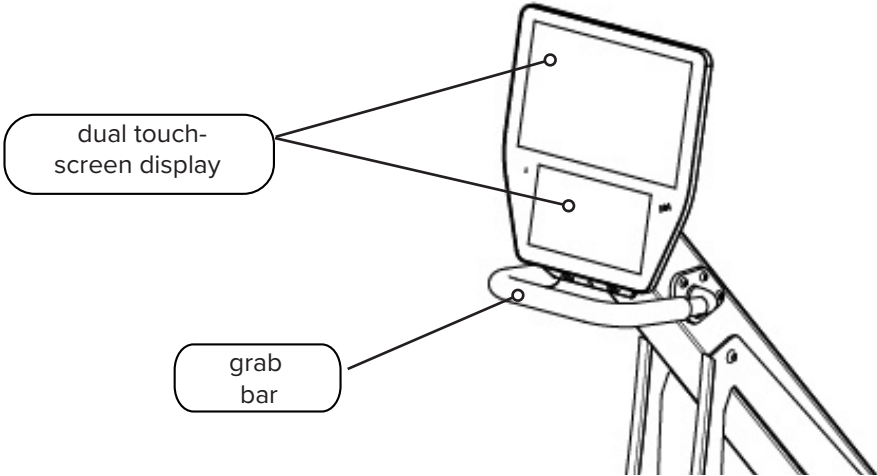
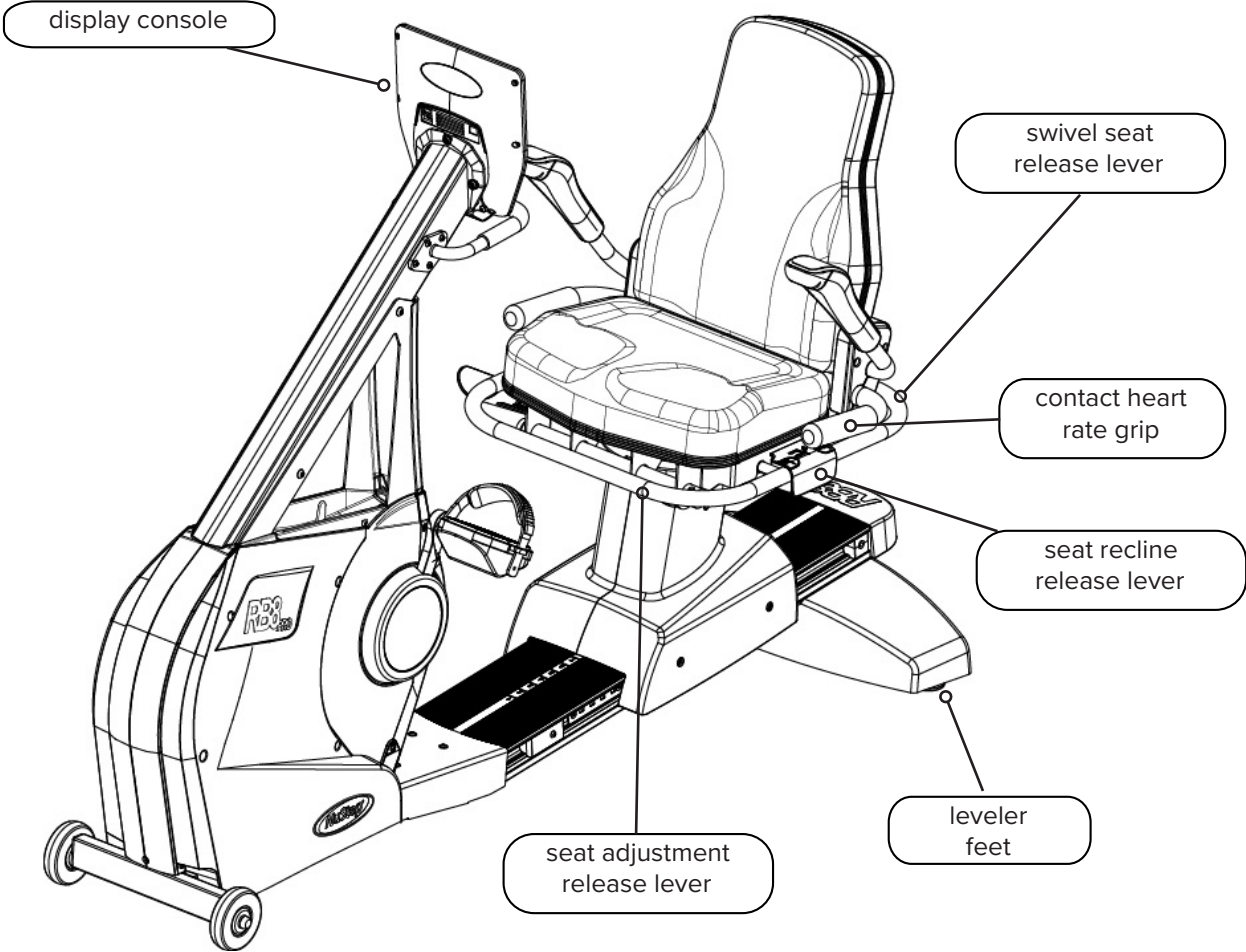

Making Adjustments

Swivel Seat Operation

1. Place feet firmly on the rail or floor.
2. Lift the rear release lever to unlock seat.
3. Swivel the seat in either direction (seat swivels 360° and locks every 45°).
4. Release the lever to lock seat in position.

 The seat can rotate with or without a user on the machine. For safety, the seat must be facing forward to adjust distance.



Lift rear lever to unlock seat.



Swivel seat in either direction.
Release lever to lock seat in place.

Adjust Seat Distance

1. Place feet firmly on the rail or floor.
2. Lift the front lever to unlock.
3. Using feet, slide seat forward or backward to adjust distance to the arm cranks.
4. Release lever to lock seat in place.

 Position the seat so that there is a slight bend in the knee when that leg is extended.



Lift front lever to adjust distance.



Knee has slight bend when leg is extended.

Making Adjustments

Adjust Seat Recline

1. Place feet firmly on the rail or floor.
2. Lift the black lever on left side of seat to unlock.
3. Push on seat back to increase recline (up to 12° recline possible).
4. Release lever to lock seat in place.



Lift lever on left side to unlock.



Push on seat back to adjust recline. Release lever to lock.

Correct Exercise Positions

The exerciser's body position and the physical configuration of the machine varies depending on the exerciser's goals or needs.

Use the information here as a general guide or starting point for setup and positioning. Correct positioning of the seat distance helps users maintain proper body posture while exercising.



CAUTION

Injuries to health may result from incorrect or excessive use.

Make sure the seat is set up in biomechanically correct positions.

Do not over-extend your leg-reach distance.

Display Screens

RB8 Console

The console has two display screens with touch screen navigation. The upper is the *Home* screen, the lower is the *Metric* screen.

Home Screen

Displays workout apps *Quick Start*, *NuStep Charts*, *Pace Partner*, *Balanced Power*, *Trail Runner* and *NuStep Programs*.

Each app is represented by an icon. To launch, tap the icon.

 To view other apps, swipe left on the *Home* screen.



Metric Screen

Displays information and settings icons, as well as workout metrics including *Time*, *Level (resistance)*, *Heart Rate*, *Calories*, *SPM (steps per minute)*, *METS*, *Miles*, and *Total Steps*.

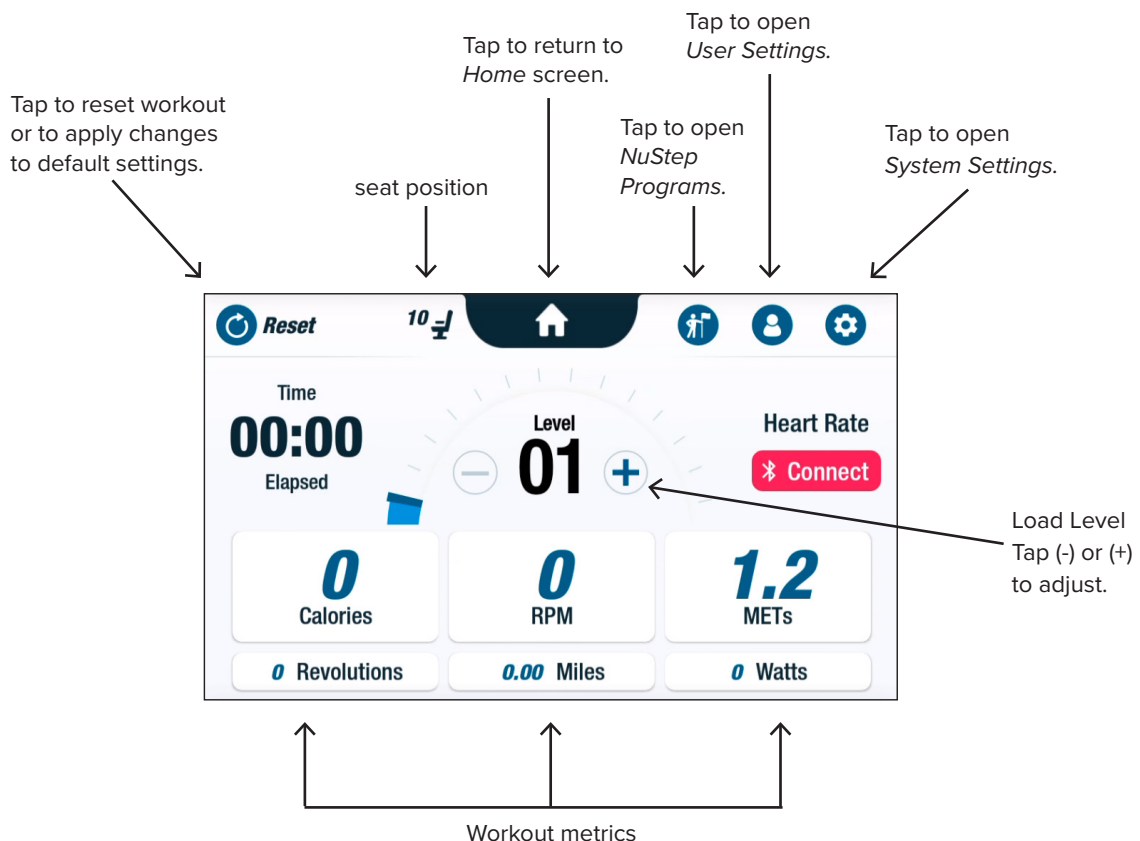



Display Screens

App Screens

Quick Start

Allows users to work out without setting pace goals or selecting metric values. *Quick Start* tracks elapsed time and total laps.

Users can switch to other apps from the *Quick Start* screen. To switch apps:

- Tap  to open the *Performance Charts* app.
- Tap  to open the *Pace Partner* app.

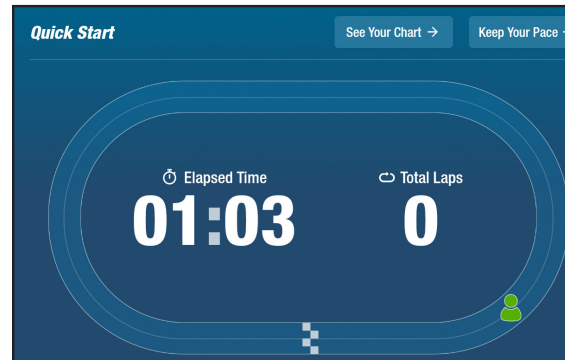

NuStep Charts

Displays performance metrics — *Pace (RPM)*, *Watts*, *Load*, *METs* or *Balance* — tracked over the course of a workout.

To switch between performance charts:

- Tap on the desired metric tab to select, e.g., *Balance*.
- The selected metric highlights in blue and displays the corresponding chart.

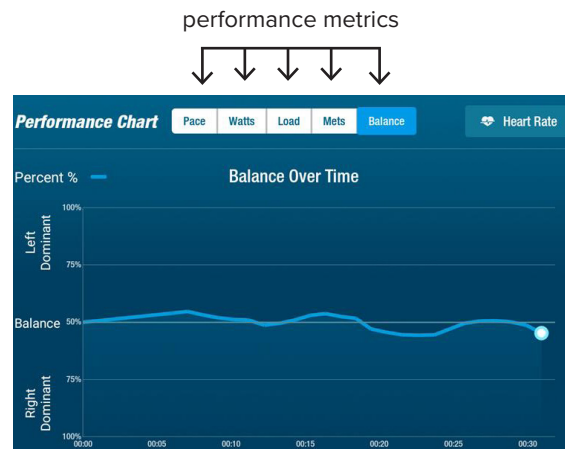

Display Screens

Pace Partner

Users set a target pace and a workout metric (*RPM*, *Watts* or *METs*). The user's goal is to keep pace with their partner.

To set target pace:

1. Tap  to open *Your Target Pace* screen.
2. Tap and move slider to set target pace.
3. Tap on desired metric, e.g., *RPM* to select.
4. Tap *Confirm* to complete.

Once the user begins cycling, the screen displays their current pace and the target pace.

- When on pace, the user's cyclist is green and next to the target cyclist (see *above right*).
- When off pace, the cyclist is orange and appears either ahead or behind their target (see *screens below*).
- Up or down arrows (*not shown*) cue the user to speed up or slow down to get back on track.

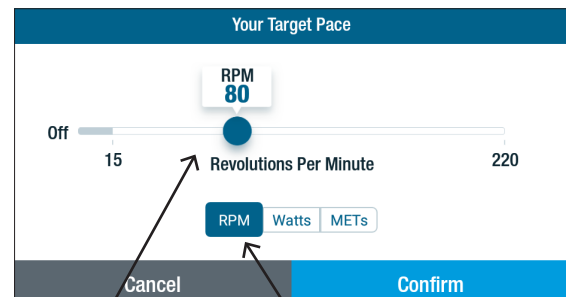
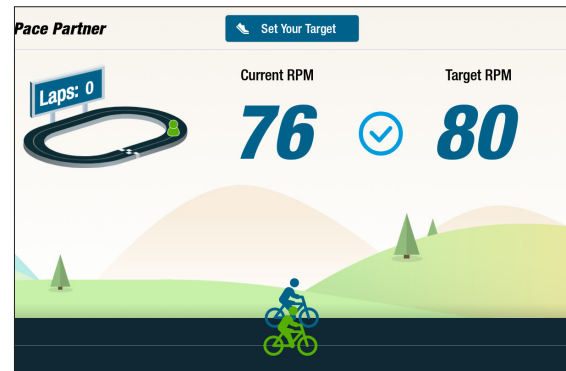

Tap and move to set pace.

Tap to select workout metric.

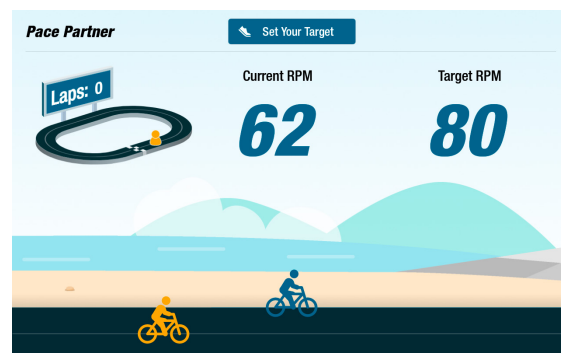
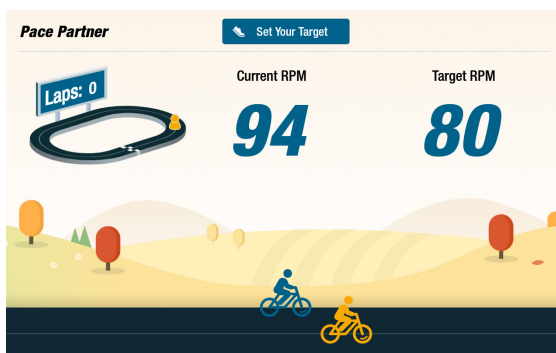

Display Screens

Balanced Power

Measures the individual power output (*Watts*) of the right leg and the left leg. Identifies their relative balance both in real-time and over the entire exercise session.

Once selected, the *Balanced Power* program continues to run in the background, collecting performance data, even while the user works out in other apps.

Performance data is displayed two ways, *Standard* and *Enhanced*.

Standard

Bar graphs display the current (real time) power generated by each leg and their relative symmetry. →

The line graph displays the percentage of balance between the left and right leg over the course of the session. →

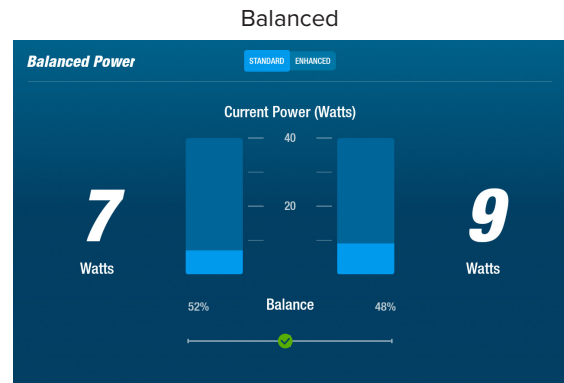

In the screens at right, the upper screen shows that the power output between the right and left legs is balanced.

The lower screen shows that the power output of the left leg is greater than the right leg and therefore imbalanced.

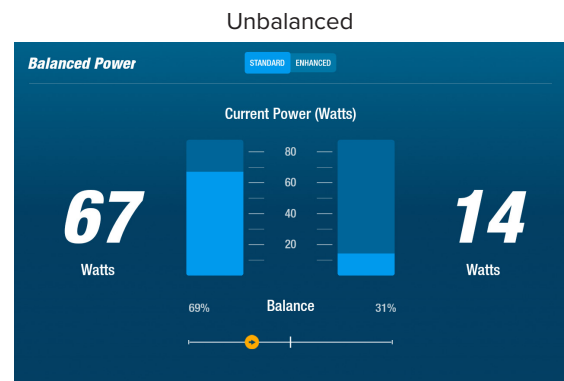

 To be balanced, the difference in power output between legs cannot be greater than 10%.

Enhanced

Also uses the bar graphs and line graph to display performance.

Adds graphics to show the radial force generated by each leg. →

This identifies where force imbalance occurs during rotation.

Tap to switch between *Standard* and *Enhanced*.

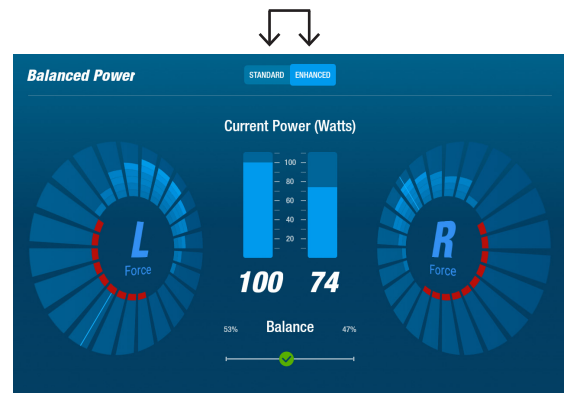

Display Screens



Trail Runner

Plays videos of scenic bike trails to engage users as they work out. To start:

1. Tap on screen image to select desired video, e.g., *Canyon Ride in Utah*. →
2. Cycle legs to play video.

To return to the *Trail Runner* menu:

1. Tap screen — the title bar drops down.
2. Tap on the back arrow in the title bar. →

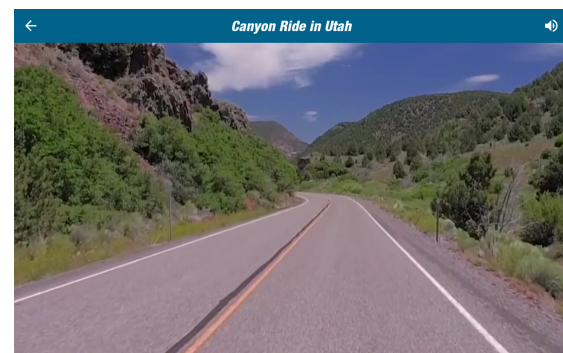

All video, audio and other content included in Trail Runner and other NuStep apps is protected under United States and international copyright laws. No right is granted to use the video, audio or other content in any manner other than as presented for viewing in NuStep Products.



NuStep Programs

Users select workout programs that focus on a specific goal (*SPM, Watts, METs, and Hills*), set a target and duration. Open from either the *Home* screen (*below left*) or the *Metric* screen (*below right*).

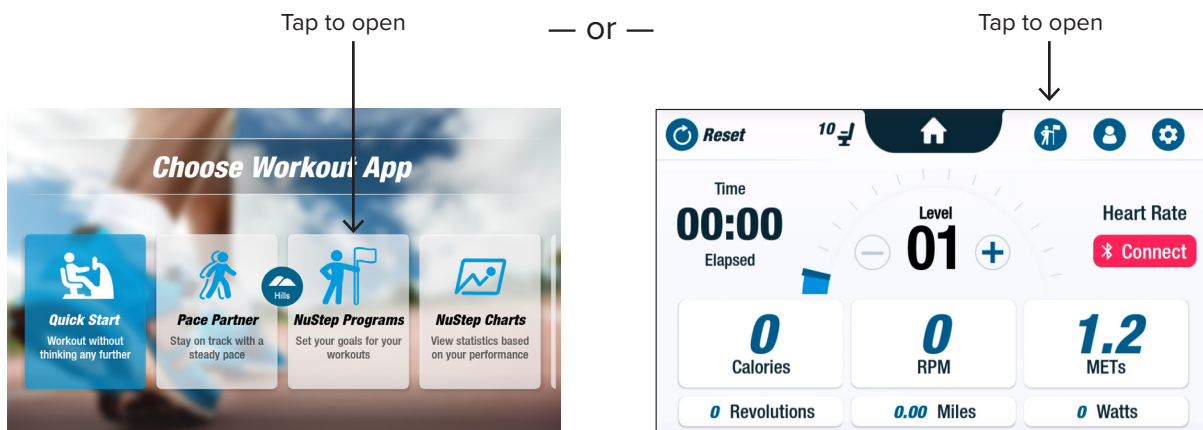



The set up for each program follows the same steps (*see following page*): 1. Select program from menu; 2. Edit settings (*Target and Duration*); 3. Start program.

Display Screens

Watts

Users set a target Watts level and duration (*minutes, distance or none*) for their workout.

To open:

1. Go to the NuStep *Programs* menu screen.
2. Tap the *Watts* icon  to open the settings screen.
3. Tap *Target* edit icon  to open set-up screen.
 - a. Use slider or tap (-) (+) to set Watts level.
 - b. Tap *Set Target* to confirm setting.
4. Tap *Duration* edit icon to open set-up screen.
 - a. Repeat steps a. and b.
5. Tap *Start Program* to run program.

Programs menu screen

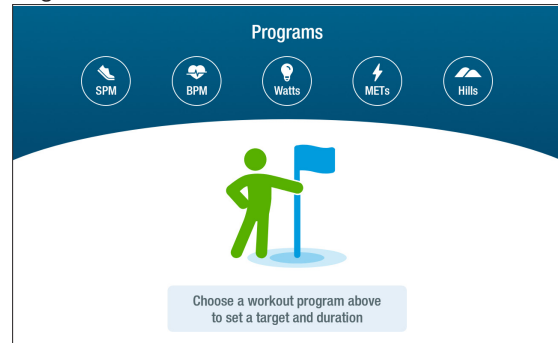

Settings screen



Watts set-up screen

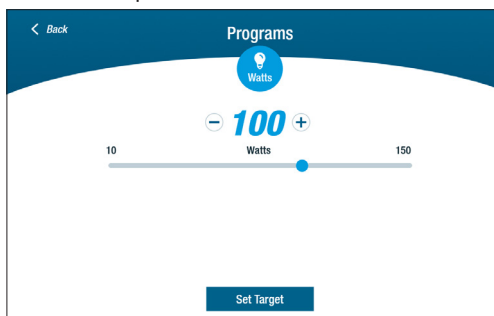

Duration set-up screen

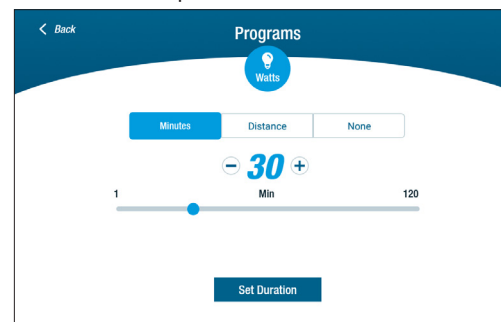

Program running screen

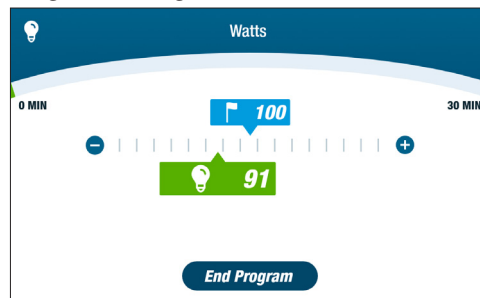

Pause Function

The RB8 has a 3-minute console shutdown. If a user stops pedaling and does not resume within 3 minutes, the console resets.

Before the console shuts down, the user can extend the pause, e.g., for interval training off the bike, for 15 minutes. While in pause mode, the user can also view a summary of their workout performance or end their workout session.

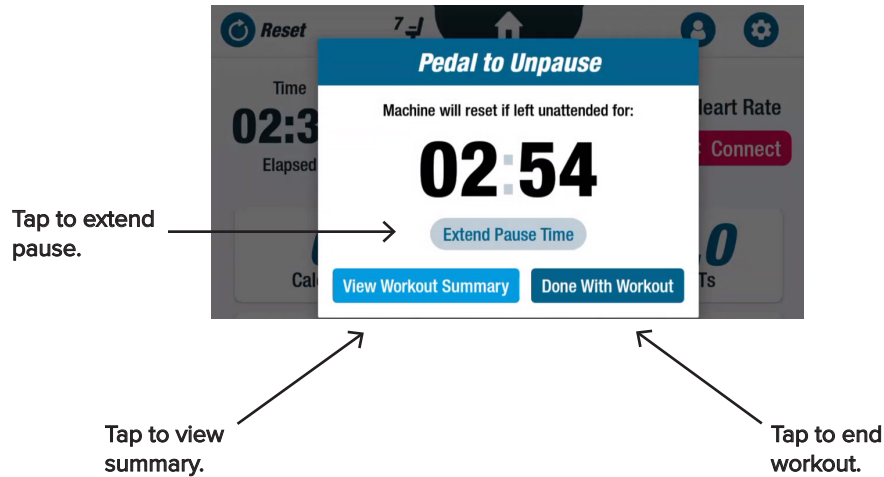

After reviewing the summary, users can return to their workout, end their workout or export their workout summary to a USB drive (see page 20 for instructions).

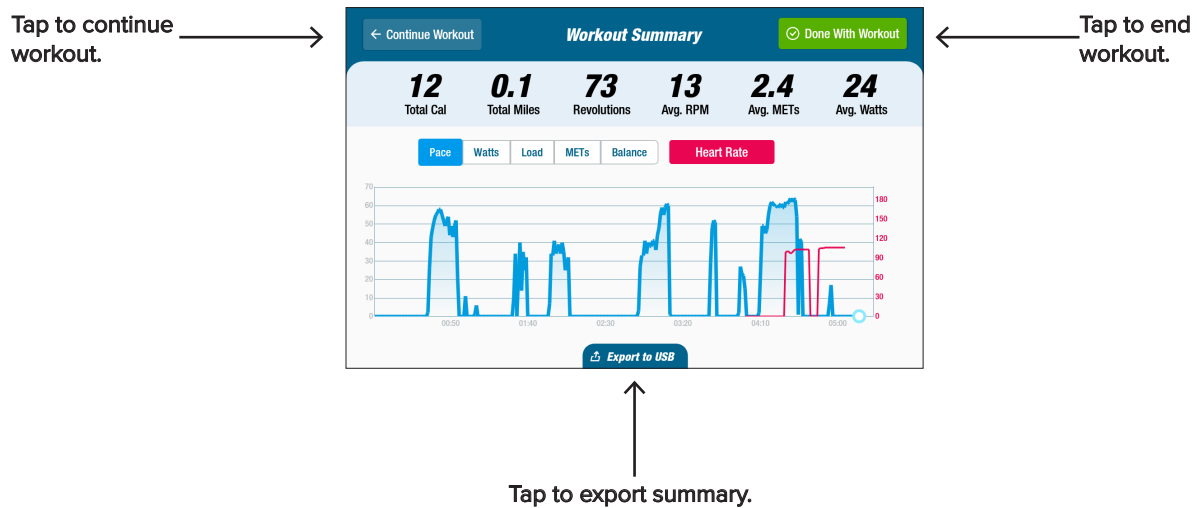

System Settings

Use to adjust volume and screen brightness, change default settings, view diagnostics, change metric configuration, view regulatory and software information.

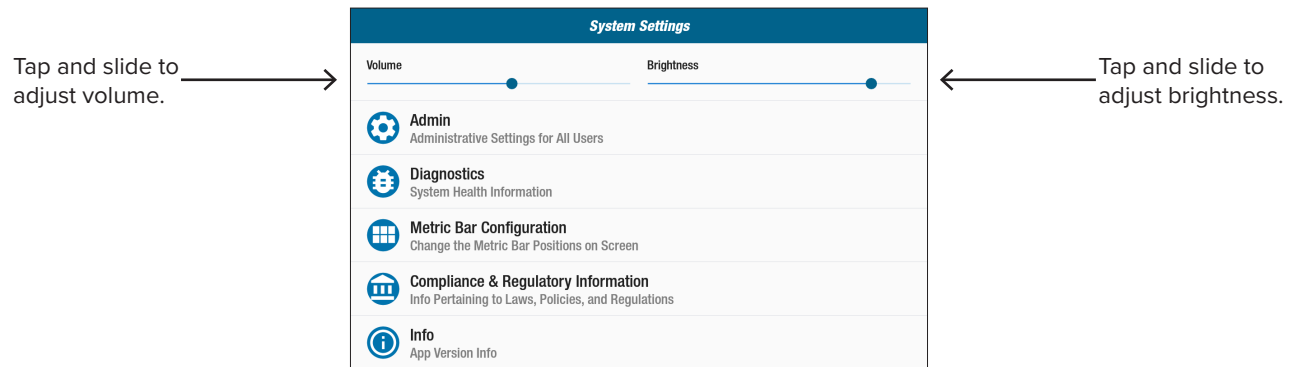

To open, go to the *Metric* screen, tap the  icon.

To adjust console volume or screen brightness, use sliders.



Admin

Requires a password* to access. Use to set or change default settings (*age, weight, gender*). The default settings are global, i.e., once set, they are the same for every user. To open the Admin screen:

1. Tap the  icon.
2. Tap screen to open numeric keyboard.
3. Enter password, tap *Submit*.
4. Tap the  icon to close keyboard.

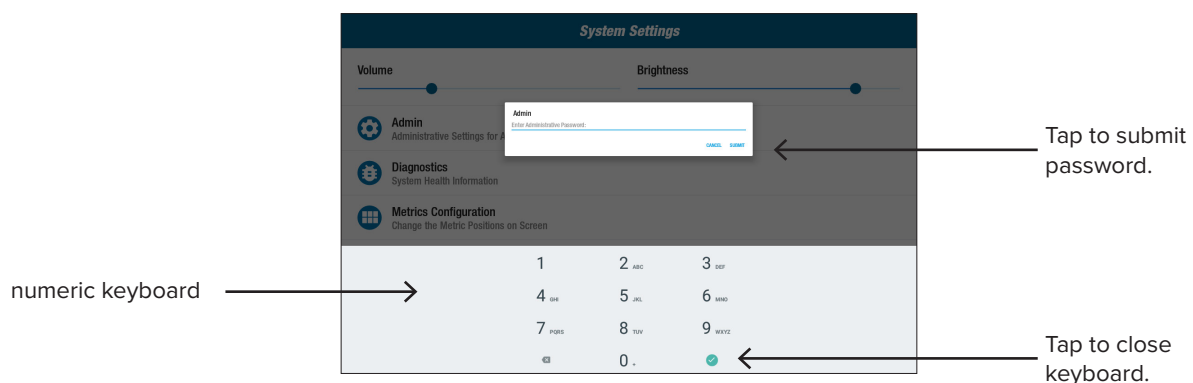

*The password is the unit's serial number entered in reverse order. For example, if the unit serial number is 1234567, then the password is 7654321. The serial number label is located on the rear support cover.

System Settings

To change default settings (*age, weight, gender*):

1. Tap into default fields.
2. Use numeric keyboard to enter age and weight; select gender.
3. Tap *Confirm*.
4. Go to the *Metric* screen.
5. Tap  **Reset** to open the *Reset Workout* screen.
6. Tap *Reset* to apply changes.

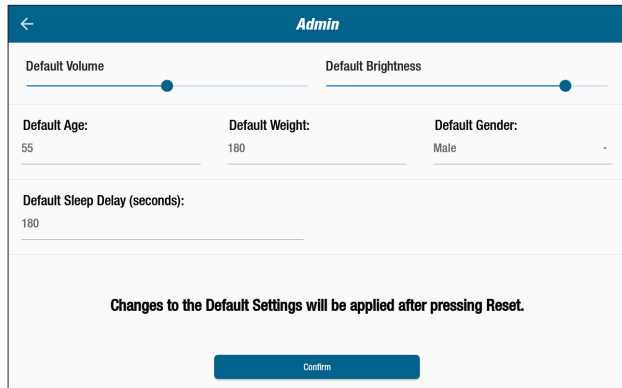

↑
Tap to confirm changes.

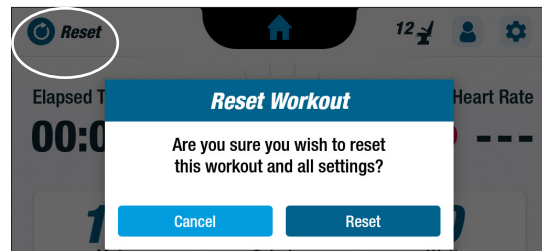

↑
Tap to reset.

Diagnostics

The diagnostics screens display live and historical data for service technicians or those responsible for equipment maintenance. The *Historical Version* screen requires a password to access. (See *previous page* for password instructions.)

To open the *Diagnostics* screen:

1. Tap the  icon on the *Systems Settings* screen
2. Tap on screen title, e.g., *Live Data*, to open.

Diagnostics		
LIVE DATA	HISTORICAL/VERSION	STATION/ROTATE
Total Revolutions 0	Seat Position 7	User Power 0.0
Status 1 0	Revolution Rate 0	
CPU Temperature 41.575		
LCB Miles 0.0	METs 1.0	Calories 0.0
Arm Height 0	Seat Present true	

Diagnostics		
LIVE DATA	HISTORICAL/VERSION	STATION/ROTATE
R8		
WRITE SERIAL 		
Serial Number R8880004		
Firmware Version 4.58	Bootloader Version 1.14	Platform Type 4
Total Restarts 108	Total Updates 0	Total Workouts 41459
Total Duration 10634	Sys Total Revolutions 4661	Sys Total Disk Revolutions 0

System Settings

Metric Bar Configuration

Users may change which metric units (*Miles, Steps, SPM, Mets, Calories, or Watts*) are displayed on the metric screen. The top row displays the current metric configuration.

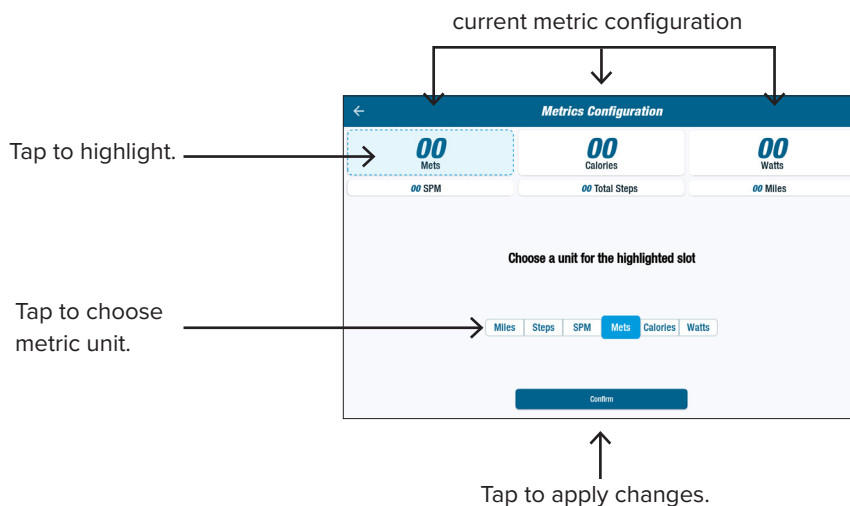

To change:

1. Tap the  icon to open *Metric Configuration* screen.
2. Tap on a current metric unit to highlight.
3. Tap to choose a different metric unit for the highlighted slot.
4. Tap *Confirm* to apply change.



User Settings

Users create and save a profile with their age, weight, sex. To create, go to the *Metric* screen:

1. Tap the  icon to open the *User Settings* screen.
2. Tap into each field to enter age and weight; select sex.
3. To save settings, insert a USB drive into the USB port (see image next page).
4. Tap *Export to USB*.
5. To return to the home screen, tap the Home  icon on the *Metric* screen.

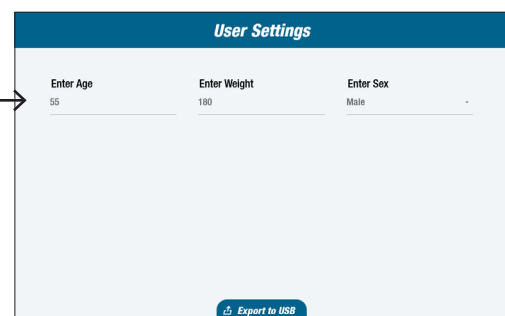

Tap to export.

Exporting User Profile Data

Users may export their profile data to a USB drive at any time.

To export:

1. Insert USB drive into the USB port on the back of the display console.
2. Tap the  icon on the *Metric* screen to open the *User Settings* screen.

Skip this step if the profile screen launches automatically.

3. Tap *Export to USB* tab at the bottom of the screen.
4. Remove USB drive.



Tap icon to open *User Settings*.

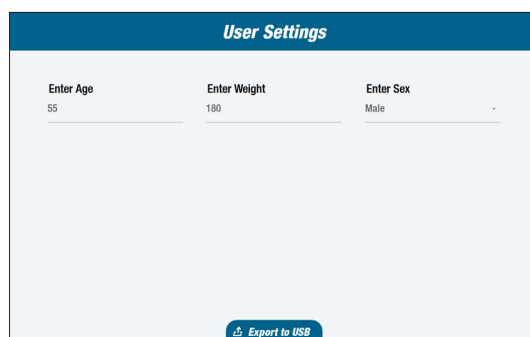
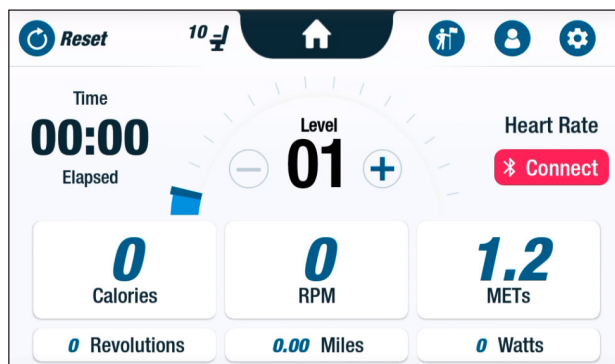

Tap to export profile data.

Exporting Workout Summary

Users may export their workout summary to a USB drive. The summary is saved in a PDF format.

 Insert a USB drive into the USB port before working out to enable export.

At the end of a workout (and the user has stopped cycling for 3 minutes) the *Pedal to Unpause* screen opens.

1. Tap *View Workout Summary* to open summary screen.

 Do not tap *Done With Workout* as this ends the session and resets the machine. The summary data is no longer available.

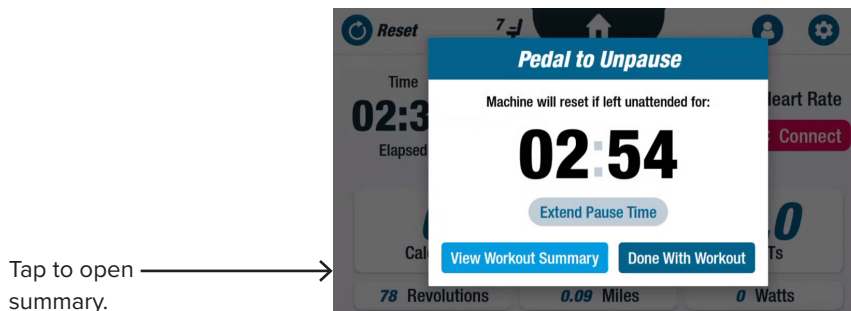

2. Tap on a metric, e.g., *Pace*, to display summary. From the *Workout Summary* screen, tap *Export to USB*.

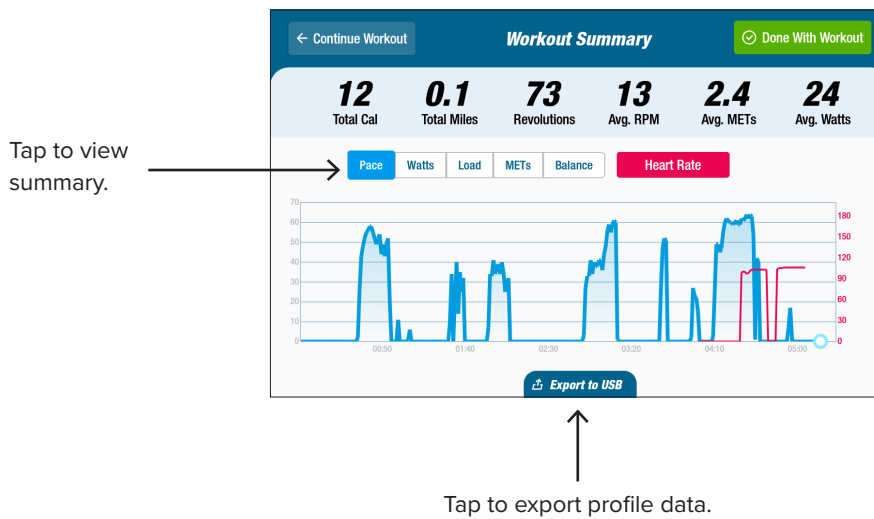

Preventive Maintenance

Preventive Maintenance Intervals

The RB8 is a high quality, durable piece of equipment designed for commercial use. A few tasks are recommended to ensure safe operation and increase the useful life of the product. Please follow the recommended preventive maintenance intervals according to the amount of usage that the product receives. These are estimated intervals and you may need to increase or decrease the time period between preventive maintenance depending on your actual use.

ITEM	TASK	FREQUENCY
Arms, Handles and Grips	* Clean	Weekly
Console	* Clean	Weekly
Covers and Frame	* Clean	Weekly
Seat	* Clean	Weekly
AC adapter	Inspect for signs of wear or damage	Weekly
*Use a non-abrasive spray cleaner and a soft cloth to clean the RB8. Unplug the equipment before cleaning.		

RB8 Warranty

To view or print your warranty, go to: www.nustep.com

For questions about your warranty, please contact customer service.

Email: support@nustep.com

Phone: 800-322-2209 (U.S.) or 734-769-3939



For customers outside the U.S. and Canada, please contact your local NuStep distributor for assistance.

RB8 Serial Number Information

Location on the product:

The serial number label is located on the left side of the rear support cover.

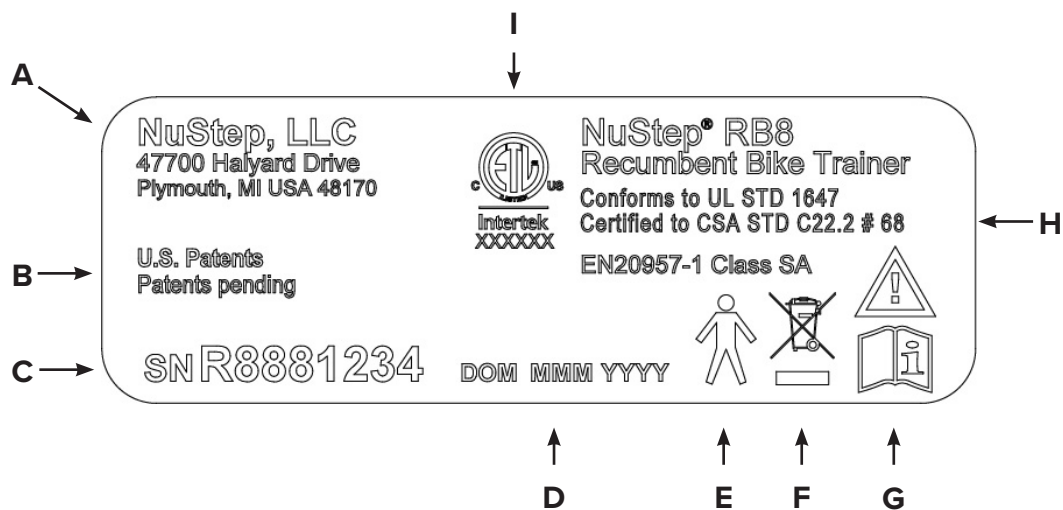

A	Manufacturer's name and address
B	Patent protection for the product
C	Model and serial number
D	Date of manufacture
E	Type B applied part for electrical safety
F	WEEE Directive Mark
G	Read the user manual before use
H	Compliance with standards
I	Nationally Recognized Test Lab Mark

Label content may vary depending on NuStep model.

Customer Service

For assistance with your RB8 unit, please contact NuStep customer service.

Please have the serial number of the unit (located on the right side of the rear support cover) and a complete description of the problem so our product specialists can better assist you.

To reach a NuStep product specialist, please contact:

Email: support@nustep.com

Phone: 800-322-2209 (U.S.)
734-769-3939

Web: nustep.com



For customers outside the U.S. and Canada, please contact your local NuStep distributor for customer service.

Technical Data

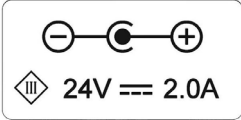
Maximum user weight	RB8PRO Model: 500 lbs. (227 kg) RB8MAX Model: 600 lbs. (272 kg)
User height range	4'6" – 6'7" (137 cm – 200 cm)
Weight of equipment	240 lbs. (109 kg)
Dimensions (length/height/width)	74" (188 cm) long; 32" (82 cm) wide
USB A Port	USB port is for flash drive use only. Some flash drives may not be compatible with the RB8 USB port. Do not connect external devices to this port with USB cables.
USB C Port	Connection for service only.
Ethernet Port	Connection for local network only. Do not connect the RB8 to internet. When connecting an ethernet cable to the product, attach a Laird hinged ferrite (manufacturer part number 28A2025-0A0) to cable between 10 – 30 cm from the console connector. The Laird ferrite may be substituted by other ferrites with equivalent technical specifications.
Standards	UL 1647, CSA C22.2#68
Braking system and cycling action	The RB8 features a speed-independent braking resistance system.
AC Adapter	<p>The RB8 is only to be used with the power supply provided with the unit. Model GlobTek TR9KI3750CCP-IM(R6B) Class 2 Output Rating: 24 Vdc 3.75A, 90W Input Rating: 100 – 240 VAC ~ 50 – 60 Hz 1.5A</p>  <p>The RB8 must only be supplied at safety extra low voltage corresponding to the marking on the product.</p>
Specifications of environmental conditions of transport, storage and operation	<p>Transport and Storage: -10 to 50 degrees celsius < 95% non-condensing humidity 20 to 107 kPa</p> <p>Operation: 5 to 35 degrees celsius < 85% non-condensing humidity 60 to 107 kPa</p>

US FCC Compliance

US FCC Compliance Statement:

Note: This equipment has been tested and found to comply with the limits for a Class B Digital Device, pursuant to Part 15 of the FCC Rules. These limits are designed to provide reasonable protection against harmful interference in a residential installation. This equipment generates, uses and can generate radio frequency energy and, if not installed and used in accordance with the installation instructions, may cause harmful interference to radio communications. However, there is no guarantee that interference may not occur in a particular installation. If the equipment causes harmful interference to radio or television reception, which can be determined by turning this equipment off and on, the user is encouraged to try and correct the interference by one or more of the following measures:

- Reorient or relocate the receiving antenna
- Increase the separation between the equipment and the receiver
- Connect the equipment into an outlet on a circuit that is different from that to which the receiver is connected
- Consult the dealer or an experienced radio/TV technician for help

Trademarks

The Bluetooth® word mark and logos are registered trademarks owned by the Bluetooth SIG, Inc. and any use of such marks by NuStep, LLC is under license. Other trademarks and trade names are those of their respective owners.

NuStep, LLC
47700 Halyard Drive
Plymouth, MI 48170
U.S.A.
800-322-2209
734-769-3939
www.nustep.com



The information in this manual is the most current at the time of printing. Due to our commitment toward continuous improvement, specifications and descriptions are subject to change without notice. No part of this manual may be reproduced or transmitted in any form or by any means, electronic or mechanical, for any purpose without the express written permission of NuStep, LLC.

© Copyright May 2022 by NuStep, LLC.

NuStep® and Transforming Lives® are registered trademarks of NuStep, LLC.

Manual PN 22080 RB8 User Manual, Rev A